

Mini Inline 3 Hanger with Fiberglass Springs

Models: 7-180 (120VAC) & 7-183 (240VAC)

Mini Multi-Hanger Inline Coil

120 VAC = P/N 6-42-115

240 VAC = P/N 6-42-128

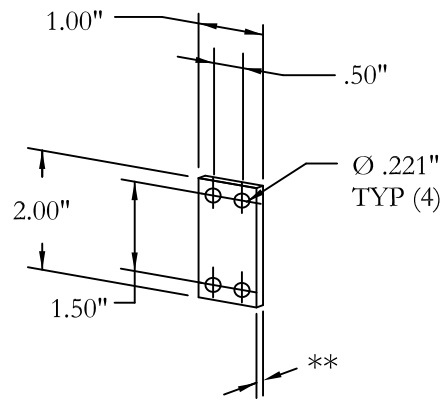

Mini Multi-Hanger Inline Fiberglass Springs

** .062" Thk = P/N 90-3-19

.093" Thk = P/N 90-3-20

Coils:

120 VAC: P/N 6-42-115

240 VAC: P/N 6-42-128

Jack Screw: P/N 8-65-02

Springs:

Upper = P/N 90-3-19 = .062" Thk

Lower = P/N 90-3-20 = .093" Thk

Spacer: P/N 88-3-119

Drawing has no scale

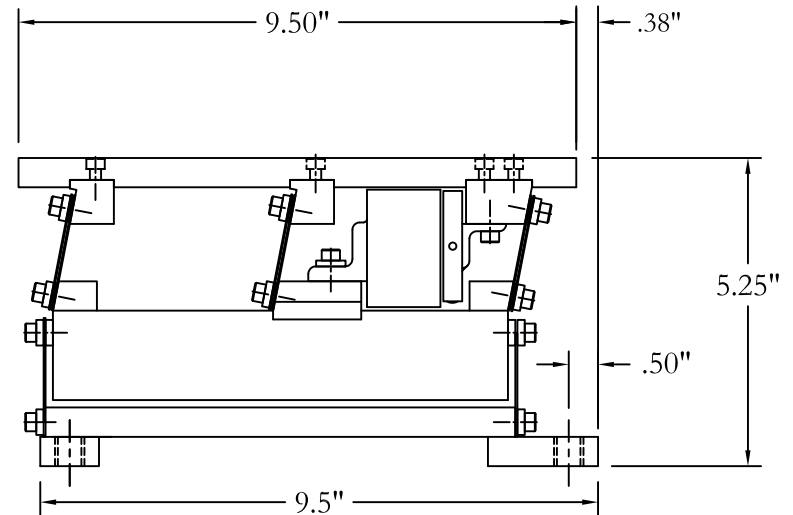
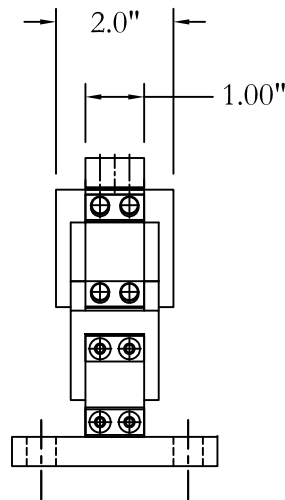
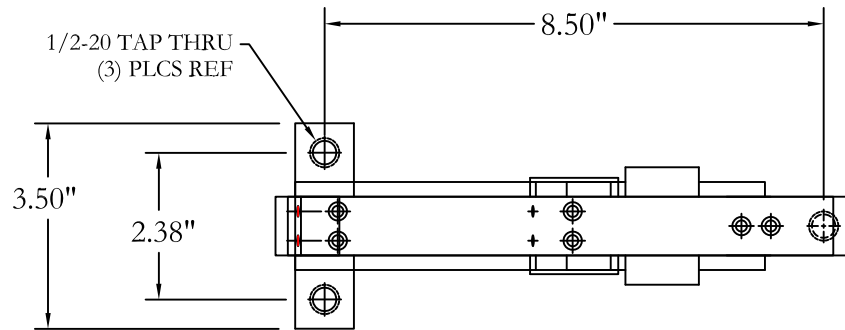

Models 7-180 & 7-183

Max Track Length: 14.75"

Track weight limitations: 5 pounds maximum

Height Adjustment Using Jack Screws: 5.875" to 7.25"

Electrical power: 7-180: 120VAC, 50/60 Hz, .5 Amps

7-183: 240VAC, 50/60 Hz, .25 Amps

Unit Weight: 11 lbs



Rodix, Inc. 2316 23rd Ave.
Rockford, IL 61104-7337
Ph. (800) 562-1868 Fax (815) 316-4701
www.rodix.com