



RODIX, INC.

2316 23rd Ave.
Rockford, IL 61104
Toll Free (800) 562-1868
Phone (815) 316-4700
Fax (815) 316-4701

5 CUBIC FOOT STRAIGHT FRONT VIBRATORY HOPPER

Our hoppers are manufactured using the finest materials and components and are delivered beautifully finished, assembled and ready for installation.

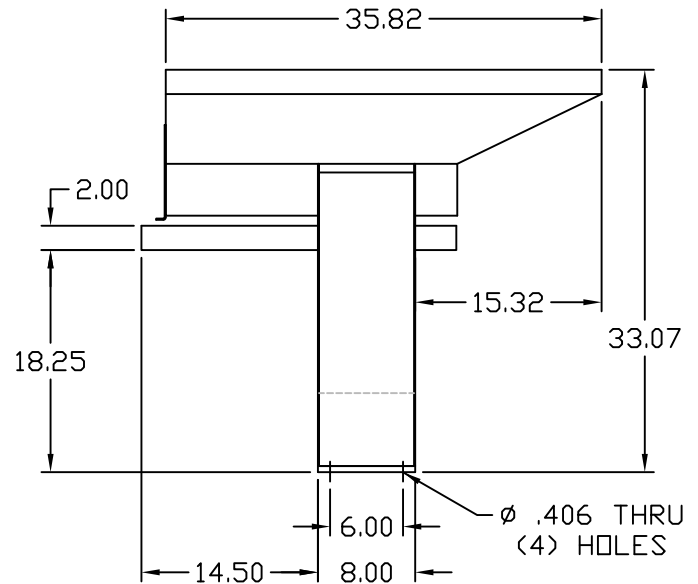
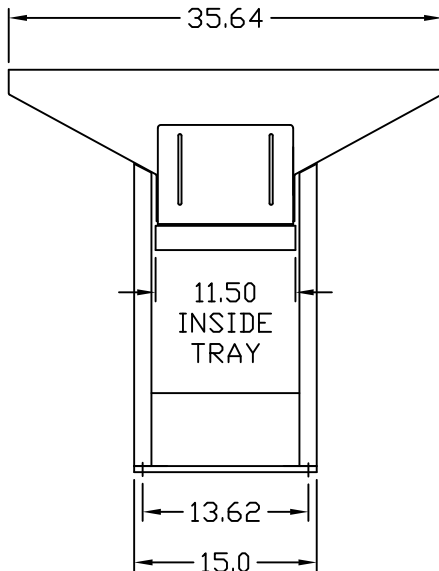
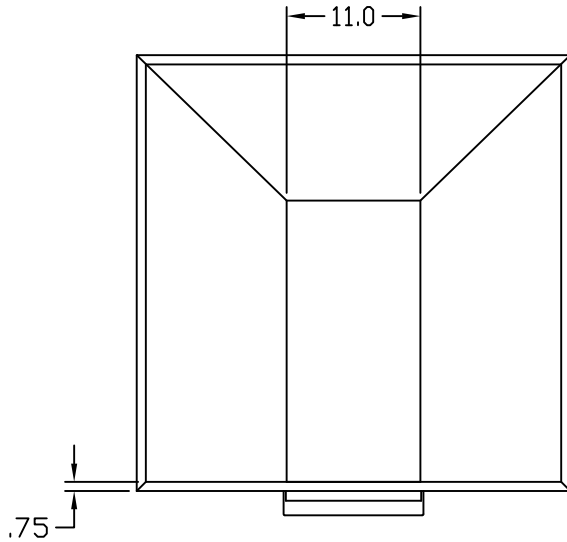

Dimensions are for reference only.

Cold rolled steel vibratory hoppers are shipped as follows:

- * 11 ga C.R.S. fully welded construction, Primed Finish
- * 120 VAC or 240 VAC Coil Installed
- * Optional: Limit Switch with Paddle
- * Optional: Photoelectric Parts Level Sensor

Stainless steel vibratory hoppers are shipped as follows:

- * 11 ga. 304 S.S. fully welded construction, Bead Blast Finish
- * 120 VAC or 240 VAC Coil Installed
- * Optional: Limit Switch with Paddle
- * Optional: Photoelectric Parts Level Sensor
- * Optional: Polished Finish

For special hopper sizes, styles, 316 S.S. or other special requests, please call for a quote.